

COUPLING

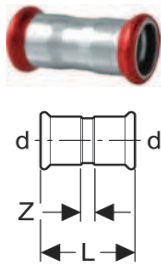

Part No.	d	L	Z	weight gramm	bag quantity	min. lot
C10AB-LBP	12	42	6	24	20	200
C10AC-LBP	15	52	10	36	20	200
C10AD-LBP	18	52	10	45	20	200
C10AE-LBP	22	59	13	60	20	200
C10AF-LBP	28	61	13	77	20	200
C10AG-LBP	35	72	18	103	10	200
C10AH-LBP	42	79	15	142	8	120
C10AJ-LBP	54	90	16	202	6	108
C10AK	76,1	142	32	596	*	20
C10AL	88,9	163	37	814	*	10
C10AM	108	192	38	1.178	*	10

SLIP COUPLING

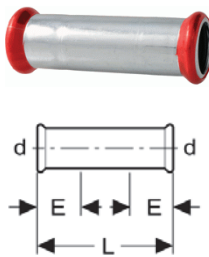

Part No.	d	L	E	weight gramm	bag quantity	min. lot
C11AB-LBP	12	56	22	32	20	200
C11AC-LBP	15	75	24	51	20	200
C11AD-LBP	18	77	25	60	20	100
C11AE-LBP	22	86	27	81	20	100
C11AF-LBP	28	92	28	112	20	100
C11AG-LBP	35	99	31	138	10	60
C11AH-LBP	42	119	35	203	6	60
C11AJ-LBP	54	145	40	280	4	40
C11AK	76,1	230	60	875	*	5
C11AL	88,9	262	70	1.200	*	5
C11AM	108	304	80	1.705	*	5

REDUCER WITH PLAIN END

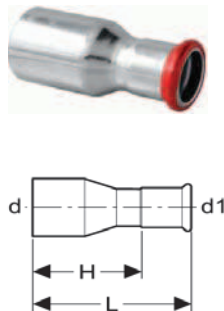

Part No.	d - d1	L	H	weight gramm	bag quantity	min. lot
C12CB-LBP	15-12	51	33	28	20	200
C12DB-LBP	18-12	53	35	30	20	200
C12DC-LBP	18-15	55	34	36	20	200
C12EB-LBP	22-12	60	42	39	20	200
C12EC-LBP	22-15	60	39	42	20	200
C12ED-LBP	22-18	57	36	44	20	200
C12FB-LBP	28-12	75	57	55	20	100
C12FC-LBP	28-15	81	60	65	20	100
C12FD-LBP	28-18	84	63	68	20	100
C12FE-LBP	28-22	70	47	67	20	200
C12GC-LBP	35-15	84	63	86	10	60
C12GD-LBP	35-18	87	66	90	10	60
C12GE-LBP	35-22	76	53	92	10	100
C12GF-LBP	35-28	74	48	87	10	100
C12HD-LBP	42-18	98	77	180	6	30
C12HE-LBP	42-22	87	64	118	6	60
C12HF-LBP	42-28	100	76	128	6	60
C12HG-LBP	42-35	78	52	115	6	60
C12JD-LBP	54-18	108	87	190	4	32
C12JE-LBP	54-22	110	88	185	4	40
C12JF-LBP	54-28	100	76	185	4	40
C12JG-LBP	54-35	129	102	204	4	40
C12JH-LBP	54-42	108	76	189	4	40
C12KH-LBP	76,1-42	151	119	425	*	10
C12KJ-LBP	76,1-54	145	108	454	*	10
C12LJ-LBP	88,9-54	157	120	596	*	10
C12LK	88,9-76,1	157	105	660	*	10
C12MJ-LBP	108-54	204	167	898	*	10
C12MK	108-76,1	196	144	948	*	10
C12ML	108-88,9	192	133	996	*	10

BEND 90° R 1,2

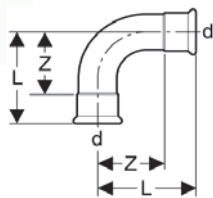

		L	Z	weight gramm	bag quantity	min. lot
C20ZB-LBP	12	42	24	40	20	200
C20ZC-LBP	15	41	20	47	20	200
C20ZD-LBP	18	45	24	58	20	200
C20ZE-LBP	22	49	26	78	20	200
C20ZF-LBP	28	59	35	112	10	200
C20ZG-LBP	35	72	45	175	10	160
C20ZH-LBP	42	91	59	246	6	60
C20ZJ-LBP	54	110	73	395	6	60
C20ZK	76,1	150	95	994	*	20
C20ZL	88,9	174	111	1.364	*	20
C20ZM	108	215	138	2.060	*	20

BEND 90° WITH PLAIN END R 1,2

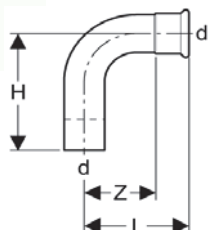

Part No.	d	L	H	Z	weight gramm	bag quantity	min. lot
C21ZB-LBP	12	42	48	24	35	20	200
C21ZC-LBP	15	41	49	20	48	20	200
C21ZD-LBP	18	45	53	24	58	20	200
C21ZE-LBP	22	49	59	26	80	20	200
C21ZF-LBP	28	59	69	35	113	10	200
C21ZG-LBP	35	72	83	45	175	10	100
C21ZH-LBP	42	91	96	59	250	6	60
C21ZJ-LBP	54	110	116	73	392	6	60
C21ZK	76,1	150	166	95	1.006	*	10
C21ZL	88,9	174	190	111	1.378	*	10
C21ZM	108	215	230	138	2.028	*	10

BEND 45° R 1,2

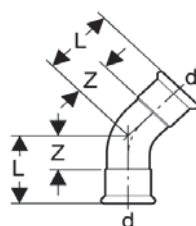

Part No.	d	L	Z	weight gramm	bag quantity	min. lot
C22ZB-LBP	12	32	14	34	20	100
C22ZC-LBP	15	30	9	39	20	200
C22ZD-LBP	18	31	10	47	20	200
C22ZE-LBP	22	35	12	63	20	200
C22ZF-LBP	28	41	17	90	10	160
C22ZG-LBP	35	56	29	150	10	100
C22ZH-LBP	42	63	31	201	5	60
C22ZJ-LBP	54	75	38	304	4	40
C22ZK	76,1	98	43	800	*	10
C22ZL	88,9	113	50	1.084	*	10
C22ZM	108	138	61	1.550	*	10

BEND 45° WITH PLAIN END R 1,2

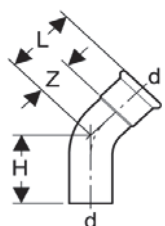

Part No.	d	L	H	Z	weight gramm	bag quantity	min. lot
C23ZB-LBP	12	32	41	14	32	20	100
C23ZC-LBP	15	30	42	9	39	20	200
C23ZD-LBP	18	31	35	10	47	20	200
C23ZE-LBP	22	35	47	12	66	20	200
C23ZF-LBP	28	41	47	17	90	10	160
C23ZG-LBP	35	36	66	29	153	10	100
C23ZH-LBP	42	63	70	31	202	5	60
C23ZJ-LBP	54	75	82	38	316	4	40
C23ZK	76,1	98	119	43	800	*	10
C23ZL	88,9	113	130	50	1.076	*	10
C23ZM	108	138	160	61	1.580	*	10

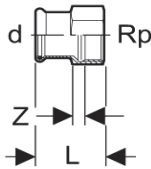
ADAPTOR WITH FEMALE THREAD

Part No.	d - Rp	L	Z	weight gramm	bag quantity	min. lot
C80NB-LBP	12-Rp ^{3/8}	31	3	53	20	120
C80PB-LBP	12-Rp ^{1/2}	35	5	45	20	120
C80NC-LBP	15-Rp ^{3/8}	35	4	65	20	100
C80PC-LBP	15-Rp ^{1/2}	37	4	70	20	200
C80QC-LBP	15-Rp ^{3/4}	38	4	71	20	100
C80PD-LBP	18-Rp ^{1/2}	37	4	57	20	160
C80QD-LBP	18-Rp ^{3/4}	38	4	75	20	160
C80PE-LBP	22-Rp ^{1/2}	37	3	87	20	160
C80QE-LBP	22-Rp ^{3/4}	40	4	80	20	200
C80RE-LBP	22-Rp ¹	43	4	114	20	120
C80PF-LBP	28-Rp ^{1/2}	45	9	191	10	120
C80QF-LBP	28-Rp ^{3/4}	43	6	139	10	120
C80RF-LBP	28-Rp ¹	45	5	119	10	200
C80RG-LBP	35-Rp ¹	45	8	130	10	80
C80SG-LBP	35-Rp ^{1 1/4}	73	25	300	10	120
C80TH-LBP	42-Rp ^{1 1/2}	75	20	270	5	100
C80VJ-LBP	54-Rp ²	85	18	360	5	80

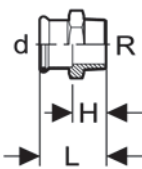
ADAPTOR WITH MALE THREAD

Part No.	d - R	L	H	weight gramm	bag quantity	min. lot
C81NB-LBP	12-R ^{3/8}	36	18	38	20	120
C81PB-LBP	12-R ^{1/2}	40	22	45	20	120
C81NC-LBP	15-R ^{3/8}	43	22	41	20	200
C81PC-LBP	15-R ^{1/2}	43	22	55	20	200
C81QC-LBP	15-R ^{3/4}	44	23	87	20	100
C81PD-LBP	18-R ^{1/2}	44	23	65	20	200
C81QD-LBP	18-R ^{3/4}	45	24	79	20	160
C81PE-LBP	22-R ^{1/2}	44	21	75	20	160
C81QE-LBP	22-R ^{3/4}	45	22	95	20	200
C81RE-LBP	22-R ¹	47	24	154	20	200
C81QF-LBP	28-R ^{3/4}	47	23	101	10	200
C81RF-LBP	28-R ¹	49	25	107	10	200
C81SG-LBP	35-R ^{1 1/4}	54	27	169	10	200
C81TG-LBP	35-R ^{1 1/2}	54	27	172	10	100
C81TH-LBP	42-R ^{1 1/2}	58	26	226	6	84
C81VJ-LBP	54-R ²	69	32	368	4	80
C81XK	76,1-R ^{2 1/2}	123	68	830	*	10
C81YL	88,9-R ³	134	71	1.160	*	10
C81ZM	108-R ⁴	156	78	2.005	*	5

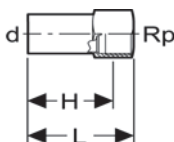
ADAPTOR WITH FEMALE THREAD AND PLAIN END

Part No.	d - Rp	L	H	weight gramm	bag quantity	min. lot
C86NB	12-Rp ^{3/8}	54	44	52	*	60
C86PB	12-Rp ^{1/2}	58	46	60	*	60
C86NC	15-Rp ^{3/8}	74	64	57	*	60
C86PC	15-Rp ^{1/2}	61	49	60	*	60
C86PD	18-Rp ^{1/2}	61	49	62	*	60
C86QD	18-Rp ^{3/4}	64	51	91	*	60
C86PE	22-Rp ^{1/2}	61	49	65	*	60
C86QE	22-Rp ^{3/4}	65	52	93	*	60

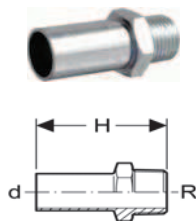
**ADAPTOR WITH MALE
THREAD AND PLAIN END**

Part No.	d - R	H	weight gramm	bag quantity	min. lot
C87NB	12-R ³ / ₈	50	40	*	60
C87PB	12-R ¹ / ₂	55	58	*	60
C87PC	15-R ¹ / ₂	57	70	*	60
C87PD	18-R ¹ / ₂	57	74	*	60
C87QD	18-R ³ / ₄	59	103	*	60
C87PE	22-R ¹ / ₂	57	77	*	60
C87QE	22-R ³ / ₄	59	105	*	60

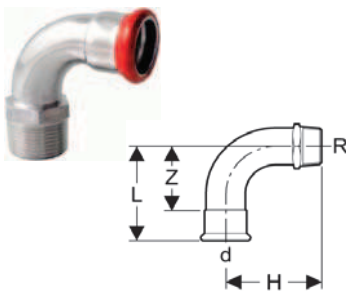
**BEND ADAPTOR 90°
WITH MALE THREAD**

Part No.	d - R	L	H	Z	weight gramm	bag quantity	min. lot
C83NB-LBP	12-R ³ / ₈	42	34	24	53	20	40
C83NC-LBP	15-R ³ / ₈	41	39	20	62	20	40
C83PC-LBP	15-R ¹ / ₂	41	40	20	70	20	60
C83PD-LBP	18-R ¹ / ₂	45	48	24	70	20	60
C83QE-LBP	22-R ³ / ₄	49	54	26	106	10	60
C83RF-LBP	28-R ¹	59	68	35	180	10	40
C83SG-LBP	35-R ¹ / ₄	72	102	45	259	10	30
C83TH-LBP	42-R ¹ / ₂	91	116	59	375	5	30
C83VJ-LBP	54-R ²	110	142	73	670	5	30

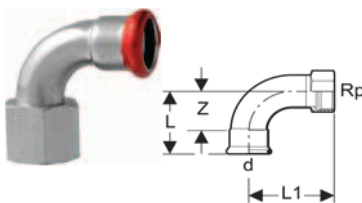
**BEND ADAPTOR 90°
WITH FEMALE THREAD**

Part No.	d - Rp	L	L1	Z	weight gramm	bag quantity	min. lot
C82NB-LBP	12-Rp ³ / ₈	42	41	24	55	20	40
C82NC-LBP	15-Rp ³ / ₈	41	44	20	60	20	40
C82PC-LBP	15-Rp ¹ / ₂	41	44	20	74	20	40
C82PD-LBP	18-Rp ¹ / ₂	45	51	24	84	20	40
C82QE-LBP	22-Rp ³ / ₄	49	56	26	119	10	40
C82PF-LBP	28-Rp ¹ / ₂	59	64	35	97	10	40

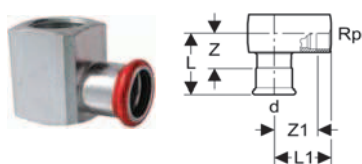
**ELBOW ADAPTOR 90°
WITH FEMALE THREAD**

Part No.	d - Rp	L	L1	Z	Z1	weight gramm	bag quantity	min. lot
C30PC-LBP	15-Rp ¹ / ₂	36	27	15	15	171	20	100
C30PD-LBP	18-Rp ¹ / ₂	36	27	15	15	172	10	80
C30PE-LBP	22-Rp ¹ / ₂	42	40	19	28	236	10	50
C30QE-LBP	22-Rp ³ / ₄	42	30	19	17	292	10	50
C30PF-LBP	28-Rp ¹ / ₂	47	43	23	31	454	10	40

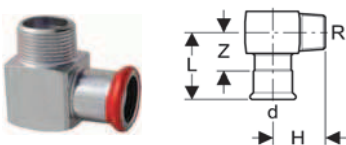
**ELBOW ADAPTOR 90°
WITH MALE THREAD**

Part No.	d - R	L	H	Z	weight gramm	bag quantity	min. lot
C31NB-LBP	12-R ³ / ₈	34	21	16	84	20	120
C31NC-LBP	15-R ³ / ₈	34	23	13	82	20	120
C31PC-LBP	15-R ¹ / ₂	34	28	13	95	20	120
C31PD-LBP	18-R ¹ / ₂	36	26	15	110	20	80
C31QD-LBP	18-R ³ / ₄	37	31	16	150	10	60
C31QE-LBP	22-R ³ / ₄	39	36	16	190	10	60

T-PIECE EQUAL

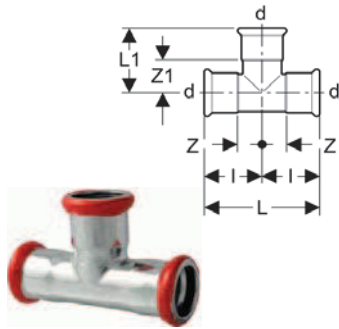

Part No.	d	L	L1	Z	Z1	I	weight gramm	bag quantity	min. lot
C40AB-LBP	12	56	35	10	17	28	46	20	200
C40AC-LBP	15	74	36	16	15	37	67	20	200
C40AD-LBP	18	80	37	19	16	40	82	20	200
C40AE-LBP	22	82	43	18	20	41	109	20	200
C40AF-LBP	28	92	46	22	22	46	144	10	200
C40AG-LBP	35	102	55	24	28	51	189	8	160
C40AH-LBP	42	118	60	27	28	59	270	5	60
C40AJ-LBP	54	142	73	34	36	71	396	4	60
C40AK	76,1	232	121	61	66	116	1.150	*	10
C40AL	88,9	262	126	68	63	131	1.640	*	10
C40AM	108	312	152	79	75	156	2.319	*	10

T-PIECE REDUCED

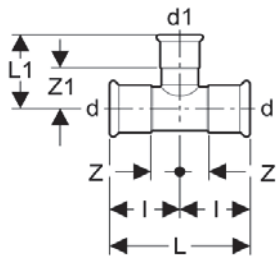

Part No.	d - d1 - d	L	L1	Z	Z1	I	weight gramm	bag quantity	min. lot
C41BC-LBP	15-12-15	74	33	16	15	37	63	20	100
C41BD-LBP	18-12-18	80	34	19	16	40	74	20	100
C41CD-LBP	18-15-18	80	35	19	14	40	78	20	200
C41BE-LBP	22-12-22	82	36	18	18	41	94	20	100
C41CE-LBP	22-15-22	82	40	18	19	41	98	20	200
C41DE-LBP	22-18-22	82	40	18	19	41	100	20	160
C41CF-LBP	28-15-28	92	42	22	21	46	126	10	180
C41DF-LBP	28-18-28	92	43	22	22	46	128	10	160
C41EF-LBP	28-22-28	92	46	22	23	46	135	10	180
C41CG-LBP	35-15-35	102	45	24	24	51	159	10	100
C41DG-LBP	35-18-35	102	45	24	24	51	160	10	100
C41EG-LBP	35-22-35	102	48	24	25	51	169	10	100
C41FG-LBP	35-28-35	102	50	24	25	51	178	10	100
C41CH-LBP	42-15-42	118	52	27	31	59	224	10	60
C41DH-LBP	42-18-42	118	52	27	31	59	228	10	40
C41EH-LBP	42-22-42	118	54	27	31	59	228	5	60
C41FH-LBP	42-28-42	118	53	27	29	59	264	4	60
C41GH-LBP	42-35-42	118	57	27	30	59	250	5	60
C41CJ-LBP	54-15-54	142	54	34	33	71	349	6	30
C41DJ-LBP	54-18-54	142	54	34	33	71	354	6	30
C41EJ-LBP	54-22-54	142	56	34	33	71	338	4	40
C41FJ-LBP	54-28-54	142	59	34	35	71	339	4	40
C41GJ-LBP	54-35-54	142	64	34	37	71	356	6	36
C41HJ-LBP	54-42-54	142	68	34	36	71	375	4	40
C41EK-LBP	76,1-22-76,1	232	68	61	45	116	986	*	10
C41FK-LBP	76,1-28-76,1	232	71	61	47	116	956	*	10
C41GK-LBP	76,1-35-76,1	232	75	61	48	116	968	*	10
C41HK-LBP	76,1-42-76,1	232	79	61	47	116	981	*	10
C41JK-LBP	76,1-54-76,1	232	80	61	43	116	1.034	*	10
C41EL-LBP	88,9-22-88,9	262	76	68	53	131	1.306	*	10
C41FL-LBP	88,9-28-88,9	262	75,5	68	51,5	131	1.244	*	10
C41GL-LBP	88,9-35-88,9	262	83	68	56,5	131	1.267	*	10
C41HL-LBP	88,9-42-88,9	262	85	68	53	131	1.271	*	10
C41JL-LBP	88,9-54-88,9	262	92,5	68	55,5	131	1.297	*	10
C41KL	88,9-76,1-88,9	262	128	68	73	131	1.572	*	10
C41EM-LBP	108-22-108	312	85	79	62	156	1.838	*	10
C41FM-LBP	108-28-108	312	87,5	79	63,5	156	1.939	*	5
C41GM-LBP	108-35-108	312	93,5	79	66	156	1.955	*	5
C41HM-LBP	108-42-108	312	96	79	64	156	1.886	*	5
C41JM-LBP	108-54-108	312	102	79	65	156	1.967	*	5
C41KM	108-76,1-108	312	125	79	70,2	156	2.147	*	5
C41LM	108-88,9-108	312	135	79	72	156	2.184	*	5

T-PIECE WITH FEMALE THREAD

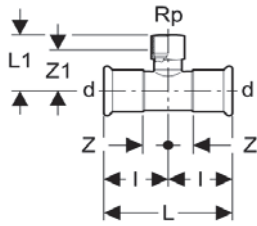

Part No.	d - Rp	L	L1	Z	Z1	I	weight gramm	bag quantity	min. lot
C42NB-LBP	12-Rp ^{3/8} -12	56	33	10	23	28	68	20	100
C42PB-LBP	12-Rp ^{1/2} -12	56	36	10	23	28	75	20	100
C42PC-LBP	15-Rp ^{1/2} -15	74	38	16	23	37	82	20	160
C42PD-LBP	18-Rp ^{1/2} -18	80	39	20	24	40	95	20	120
C42PE-LBP	22-Rp ^{1/2} -22	82	42	18	30	41	113	20	200
C42QE-LBP	22-Rp ^{3/4} -22	82	43	18	30	41	128	20	100
C42PF-LBP	28-Rp ^{1/2} -28	92	44	22	32	46	140	10	200
C42QF-LBP	28-Rp ^{3/4} -28	92	45	22	32	46	159	10	100
C42PG-LBP	35-Rp ^{1/2} -35	102	48	24	36	51	176	10	100
C42QG-LBP	35-Rp ^{3/4} -35	102	48	24	35	51	191	10	40
C42PH-LBP	42-Rp ^{1/2} -42	118	46	27	34	59	248	5	60
C42QH-LBP	42-Rp ^{3/4} -42	118	51	27	38	59	250	5	40
C42PJ-LBP	54-Rp ^{1/2} -54	142	58	34	46	74	333	6	42
C42QJ-LBP	54-Rp ^{3/4} -54	142	59	34	46	74	350	6	36
C42QK	76,1-Rp ^{3/4} -76,1	232	69	61	56	116	950	*	10
C42QL	88,9-Rp ^{3/4} -88,9	262	76	68	63	131	1.314	*	10
C42QM	108-Rp ^{3/4} -108	312	86	79	73	156	1.830	*	10

T-PIECE ENLARGED

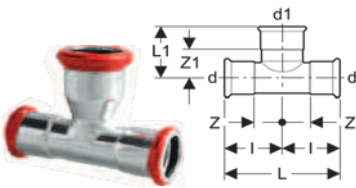

Part No.	d - d1 - d	L	L1	Z	Z1	I	weight gramm	bag quantity	min. lot
C44CB-LBP	12-15-12	56	38	10	17	28	52	20	100
C44DC-LBP	15-18-15	74	36	16	15	37	72	20	100
C44EC-LBP	15-22-15	74	42	16	19	37	86	20	100
C44ED-LBP	18-22-18	80	45	19	22	40	94	20	80
C44FE-LBP	22-28-22	82	45	18	21	41	122	10	80

PIPE CROSS 90°

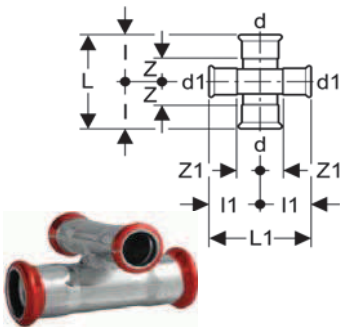

Part No.	d - d1	L	L1	Z	Z1	I	I1	weight gramm	bag quantity	min. lot
C45AC-LBP	15-15	74	74	16	16	37	37	100	10	40
C45CD-LBP	18-15	80	74	19	16	40	37	110	10	80
C45CE-LBP	22-15	82	74	18	16	41	37	130	10	80
C45DE-LBP	22-18	82	80	18	19	41	40	140	10	40
C45CF-LBP	28-15	92	74	22	16	46	37	156	10	40
C45DF-LBP	28-18	92	80	22	19	46	40	166	10	40
C45EF-LBP	28-22	92	82	22	18	46	41	186	10	20
C45EG-LBP	35-22	102	82	24	18	51	41	218	5	10
C45EH-LBP	42-22	118	82	27	18	59	41	280	5	10
C45EJ-LBP	54-22	142	82	34	18	71	41	376	5	10

CAP

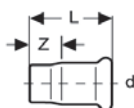

Part No.	d	L	Z	weight gramm	bag quantity	min. lot
C50AB-LBP	12	30	12	20	20	100
C50AC-LBP	15	38	17	27	20	100
C50AD-LBP	18	41	20	35	20	100
C50AE-LBP	22	42	19	45	10	100
C50AF-LBP	28	46	22	62	10	60
C50AG-LBP	35	51	24	79	10	60
C50AH-LBP	42	59	27	116	10	40
C50AJ-LBP	54	73	36	179	10	20
C50AK	76,1	95	40	376	*	5
C50AL	88,9	115	52	504	*	5
C50AM	108	130	53	707	*	5

*In compliance with the minimum lot, the bag content may vary according to the ordered quantity.

PLUG

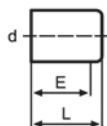

Part No.	d	L	E	weight gramm	bag quantity	min. lot
C51AB	12	36	30	14	*	60
C51AC	15	42	33	22	*	60
C51AD	18	40	33	28	*	60
C51AE	22	43	34	38	*	60
C51AF	28	47	36	50	*	60
C51AG	35	49	40	70	*	60
C51AH	42	55	44	96	*	40
C51AJ	54	65	49	144	*	20
C51AK	76,1	87	74	350	*	5
C51AL	88,9	92	78	474	*	5
C51AM	108	107	92	698	*	5

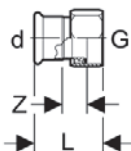
ADAPTOR WITH UNION NUT
IN BRASS AND EPDM FLAT SEAL

Part No.	G - d (ISO 228)	L	Z	weight gramm	bag quantity	min. lot
C60QC-LBP	G $\frac{3}{4}$ -15	37	11	74	*	100
C60QD-LBP	G $\frac{3}{4}$ -18	39	11	72	*	100
C60RE-LBP	G1-22	40	11	96	*	60
C60SF-LBP	G1 $\frac{1}{4}$ -28	44	13	168	*	50
C60TG-LBP	G1 $\frac{1}{2}$ -35	48	13	252	*	40
C60UH-LBP	G1 $\frac{3}{4}$ -42	52	13	286	*	20
C60WJ-LBP	G2 $\frac{3}{8}$ -54	58	15	428	*	12

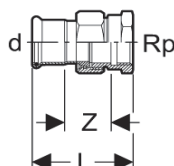
ADAPTOR UNION WITH FEMALE THREAD,
BRASS NUT AND EPDM FLAT SEAL

Part No.	d - Rp	L	Z	weight gramm	bag quantity	min. lot
C62PC-LBP	15-Rp $\frac{1}{2}$	59	26	176	*	40
C62QC-LBP	15-Rp $\frac{3}{4}$	61	26	188	*	40
C62PD-LBP	18-Rp $\frac{1}{2}$	59	26	174	*	40
C62QD-LBP	18-Rp $\frac{3}{4}$	61	26	188	*	40
C62QE-LBP	22-Rp $\frac{3}{4}$	63	27	196	*	40
C62RE-LBP	22-Rp1	66	28	234	*	40
C62RF-LBP	28-Rp1	71	31	416	*	30
C62SG-LBP	35-Rp1 $\frac{1}{4}$	77	32	494	*	24
C62TH-LBP	42-Rp1 $\frac{1}{2}$	82	33	564	*	16
C62VJ-LBP	54-Rp2	95	37	1.006	*	16

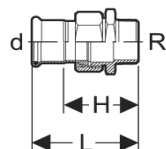
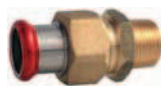
ADAPTOR UNION WITH MALE THREAD,
BRASS NUT AND EPDM FLAT SEAL

Part No.	d - R	L	H	weight gramm	bag quantity	min. lot
C64PC-LBP	15-R $\frac{1}{2}$	61	40	138	*	40
C64QC-LBP	15-R $\frac{3}{4}$	63	42	124	*	40
C64PD-LBP	18-R $\frac{1}{2}$	64	43	136	*	40
C64QD-LBP	18-R $\frac{3}{4}$	66	45	122	*	40
C64PE-LBP	22-R $\frac{1}{2}$	67	44	228	*	40
C64QE-LBP	22-R $\frac{3}{4}$	68	45	212	*	40
C64RE-LBP	22-R1	73	50	208	*	40
C64RF-LBP	28-R1	75	51	402	*	30
C64SG-LBP	35-R1 $\frac{1}{4}$	80	53	486	*	24
C64TH-LBP	42-R1 $\frac{1}{2}$	85	53	608	*	16
C64VJ-LBP	54-R2	97	60	828	*	16

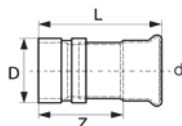
TRANSITION JOINT FOR GROOVED
FITTINGS

Part No.	d - D	L	Z	weight gramm	bag quantity	min. lot
C96EF-LBP	28x33,7					
C96SG-LBP	35x42,4					
C96TH-LBP	42x48,3					
C96VJ-LBP	54x60,3					
C96KK	76,1x76,1					
C96LL	88,9x88,9					
C96ZM	108x114,4					

in progress

Connection joint between
groove fittings e pressfittings

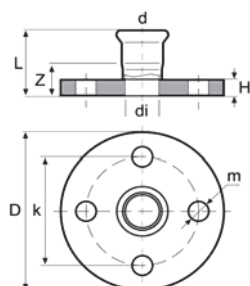
**FLANGE WITH PRESSING
SOCKET PN 16 AND PN 10/16**

Part No.	d	D	di	L	H	m	k	Z	weight gramm	bag quantity	min. lot
PN 10/16											
C52AE-LBP	22	105	21	63	16	14	75	40	676	*	20
C52AF-LBP	28	115	27	67	16	14	85	43	1.224	*	20
C52AG-LBP	35	140	32	72	18	18	100	45	2.048	*	20
C52AH-LBP	42	150	41,8	80	18	18	110	48	2.394	*	20
C52AJ-LBP	54	165	54	96	18	18	125	59	2.844	*	20
C52AK	76,1	185	72	134	18	18	145	79	3.593	*	10
C52AL	88,9	200	85	141	20	18	160	78	4.615	*	10
C52AM	108	220	104	166	20	18	180	89	5.135	*	10

Diameters 88,9 and 108 (PN 10/16) are with 8 holes

PN 6

C53AE-LBP	22	90	21	61	14	11	65	38	676	*	20
C53AF-LBP	28	100	27	65	14	11	75	41	828	*	10
C53AG-LBP	35	120	32	70	16	14	90	43	1.364	*	10
C53AH-LBP	42	130	39	77	16	14	100	45	1.608	*	10
C53AJ-LBP	54	140	54	96	16	14	110	59	1.790	*	10
C53AK	76,1	160	72	130	14	14	130	75	2.144	*	5
C53AL	88,9	190	85	137	16	18	150	74	3.306	*	5
C53AM	108	210	104	162	16	18	170	85	4.003	*	5

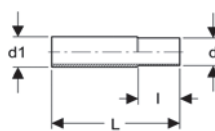
**ADAPTOR WITH PLAIN AND
WELDING END****

** Not galvanised

Part No.	d-d1	L	I	weight gramm	bag quantity	min. lot
C13AB	12-17,2	120	26	70	*	100
C13AC	15-17,2	120	30	77	*	80
C13AD	18-21,3	120	30	92	*	80
C13AE	22-26,9	120	34	131	*	50
C13AF	28-33,7	120	34	210	*	40
C13AG	35-42,4	120	40	255	*	30
C13AH	42-48,3	120	45	307	*	24
C13AJ	54-60,3	120	50	375	*	24
C13AK	76,1-76,1	120	70	500	*	10
C13AL	88,9-88,9	120	75	659	*	10
C13AM	108-114,3	120	90	880	*	10

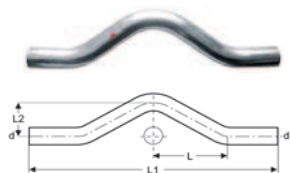
PIPE BRIDGE

Part No.	d	L1	L2	L	weight gramm	bag quantity	min. lot
C76AB	12	200	35	55	90	*	30
C76AC	15	202	37	64	110	*	30
C76AD	18	237	42	66	155	*	30
C76AE	22	233	42	58	159	*	20
C76AF	28	301	50	102	335	*	20

PIPE BRIDGE SHORT

Part No.	d	L1	L2	L	weight gramm	bag quantity	min. lot
C77AB	12	154	35	55	60	*	30
C77AC	15	145	37	57	80	*	30
C77AD	18	157	40	60	106	*	30
C77AE	22	175	52	65	147	*	30
C77AF	28	226	65	74	249	*	30

BEND 15° WITH PLAIN ENDS

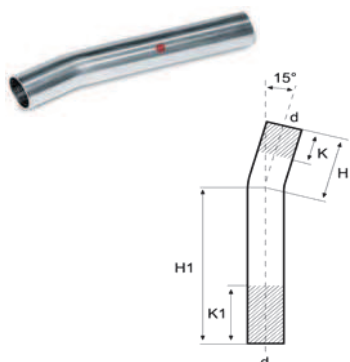

Part No.	d	H1	H	K	K1	weight gramm	bag quantity	min. lot
C75AB	12	122	60	21	83	60	*	20
C75AC	15	122	60	21	83	92	*	20
C75AD	18	128	55	15	88	90	*	20
C75AE	22	124	50	7	81	110	*	20
C75AF	28	136	45	7	47	182	*	20
C75AG	35	234	62	30	110	364	*	15
C75AH	42	276	94	44	144	528	*	8
C75AJ	54	337	117	65	165	894	*	8
C75AK	76,1	230	226	65	65	1.607	*	3
C75AL	88,9	260	240	80	80	2.109	*	3
C75AM	108	291	222	95	95	2.546	*	3

BEND 30° WITH PLAIN ENDS



Part No.	d	H1	H	K	K1	weight gramm	bag quantity	min. lot
C74AB	12	122	60	21	83	60	*	20
C74AC	15	122	60	21	83	92	*	20
C74AD	18	128	55	16	89	88	*	20
C74AE	22	124	50	6	80	110	*	20
C74AF	28	130	54	7	47	144	*	20
C74AG	35	218	80	30	110	362	*	15
C74AH	42	274	98	44	144	560	*	8
C74AJ	54	324	137	65	165	905	*	8
C74AK	76,1	200	202	66	66	1.410	*	3
C74AL	88,9	262	264	80	80	2.183	*	3
C74AM	108	259	272	95	95	2.622	*	3

BEND 45° WITH PLAIN ENDS

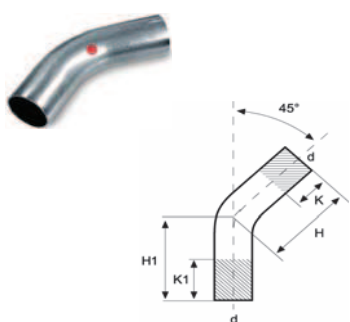

Part No.	d	H1	H	K	K1	weight gramm	bag quantity	min. lot
C73AB	12	120	62	19	77	60	*	20
C73AC	15	120	62	19	77	92	*	20
C73AD	18	124	58	16	82	88	*	20
C73AE	22	120	56	7	71	111	*	20
C73AF	28	122	58	2	66	146	*	20
C73AG	35	206	94	20	132	380	*	12
C73AH	42	262	114	1	149	576	*	8
C73AJ	54	321	146	37	212	928	*	8
C73AK	76,1	225	225	69	69	1.577	*	3
C73AL	88,9	267	267	103	103	227	*	3
C73AM	108	293	293	66	66	2.901	*	3

BEND 60° WITH PLAIN ENDS

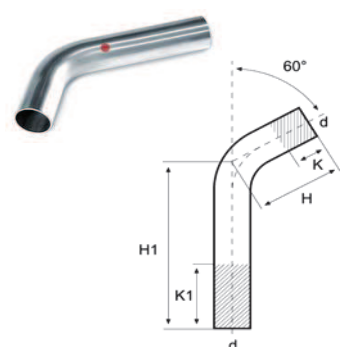

Part No.	d	H1	H	K	K1	weight gramm	bag quantity	min. lot
C72AB	12	122	60	21	83	60	*	20
C72AC	15	122	60	21	83	90	*	20
C72AD	18	122	62	16	76	110	*	20
C72AE	22	118	60	5	63	112	*	20
C72AF	28	116	71	7	47	140	*	10
C72AG	35	226	101	30	110	383	*	8
C72AH	42	251	124	44	145	564	*	8
C72AJ	54	308	162	65	165	889	*	8
C72AK	76,1	219	223	70	70	1.479	*	3
C72AL	88,9	250	257	80	80	2.090	*	3
C72AM	108	288	298	95	95	2.780	*	3

BEND 90° WITH PLAIN ENDS

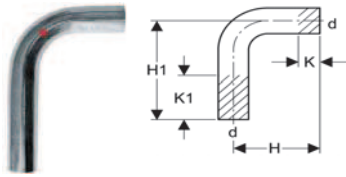

Part No.	d	H1	H	K	K1	weight gramm	bag quantity	min. lot
C70AB	12	120	70	17	67	72	*	80
C70AC	15	120	70	22	72	88	*	80
C70AD	18	120	70	17	67	103	*	60
C70AE	22	120	70	9	59	132	*	60
C70AF	28	125	97	7	47	190	*	40
C70AG	35	201	121	62	62	359	*	24
C70AH	42	254	160	90	90	553	*	24
C70AJ	54	302	202	45	45	877	*	20
C70AK	76,1	250	250	62	60	1.634	*	5
C70AL	88,9	291	291	90	90	2.240	*	5
C70AM	108	364	364	45	45	3.170	*	5

WELDING JOINT**



Part No.	d	L	weight gramm	bag quantity	min. lot
C17AB-LBP	12	23	12	*	120
C17AC-LBP	15	25	17	*	100
C17AD-LBP	18	25	21	*	80
C17AE-LBP	22	27	29	*	60
C17AF-LBP	28	30	36	*	40
C17AG-LBP	35	34	50	*	40
C17AH-LBP	42	38	65	*	20
C17AJ-LBP	54	44	97	*	20
C17AK	76,1	68	282	*	10
C17AL	88,9	78	375	*	10
C17AM	108	94	578	*	10

** Not galvanised.

Correct conditions of use have to be requested from our technical department

SINGLE CROSSING

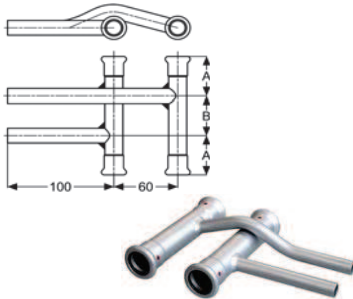

Part No.	d1-d2	A	B	weight gramm	bag quantity	min. lot
C91BB-LBP	12-12	40	40	188	*	20
C91BC-LBP	15-12	40	40	234	*	20
C91CC-LBP	15-15	40	40	250	*	20
C91BD-LBP	18-12	40	40	270	*	20
C91CD-LBP	18-15	40	40	280	*	20
C91BE-LBP	22-12	40	40	300	*	20
C91CE-LBP	22-15	40	40	320	*	20
C91BF-LBP	28-12	40	40	430	*	20
C91CF-LBP	28-15	40	40	450	*	20

DOUBLE CROSSING

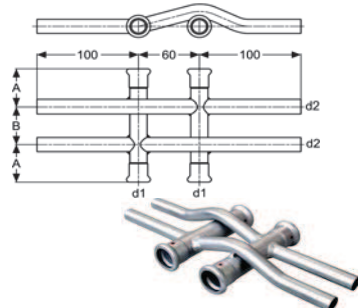

Part No.	d1-d2	A	B	weight gramm	bag quantity	min. lot
C90BB-LBP	12-12	30	40	230	*	20
C90BC-LBP	15-12	40	40	330	*	20
C90CC-LBP	15-15	40	40	355	*	20
C90BD-LBP	18-12	40	40	370	*	20
C90CD-LBP	18-15	40	40	380	*	20
C90BE-LBP	22-12	40	40	400	*	20
C90CE-LBP	22-15	40	40	420	*	20
C90BF-LBP	28-12	40	40	530	*	20
C90CF-LBP	28-15	40	40	560	*	20
C90CG-LBP	35-15	40	40	660	*	20

CROSS

Special items made on request, particularly indicated for sprinkler systems.

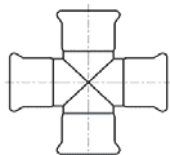

four-way cross

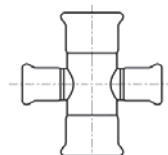

two reduced way cross

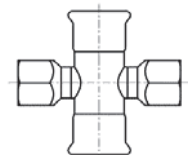

two threaded way cross

*In compliance with the minimum lot, the bag content may vary according to the ordered quantity.

Data may change without prior notice